



YOUR OEM/ODM PARTNER



Architectural & Technical Commercial Residential Architectural & Decorative Outdoor

Factory in China for Global Market

Head office: Guang Ming District, Shenzhen, China
Factory: Nai Rui Industrial Park, No.9, Xin Le No.5 Road,
Ma' an Town, Hui Cheng District,
Huizhou, Guangdong, China | PC.: 516057

Tel: (86)752 2088 669
E-mail: Sales@e-litelighting.com
www.e-litelighting.com

Factory in Malaysia for American Market

Add: 232, Lebuh Kampung Jawa, Free Industrial Zone,
Phase 3, Bayan Lepas. Penang. Malaysia.

LIGHTING PRODUCTS OVERVIEW BROCHURE

For complete product portfolio, please refers to our electronic catalogue.

23



About Us

E-Lite Lighting Co., Ltd. is a trusted OEM/ODM/NDA partner to many global lighting brands due to specialization in professional LED commercial & architectural lighting design, development and production since 2007.

Our reliable production facility, laboratory and design capability enable partners to realize the best implementation of their ideal concepts and launch cutting edge new products to build brands and markets in their countries with minimal operations investment. E-Lite's team has decades of experience in lighting industry and can provide high quality and professional comprehensive lighting solutions for customers.



Factory in China



Factory in Malaysia

Index

1 Indoor Lighting

High-Efficacy Commercial Lighting



LUCIA



LINK60

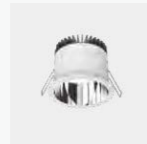

TESLA

Architectural & Technical Lighting



START



LEDGO



LINK30



FLATIA

Commercial Lighting



CREST



LUMI

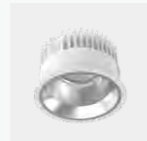

DOME

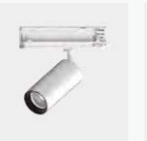

BINGO



NOVA

Residential Lighting



VTRIM



DOT



LX26



LX19



LX10



SKYLINE

2 Outdoor Lighting



FOCAL/EPO & EOS



DORI & SOLAR



PLUTO

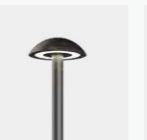

SWAMM

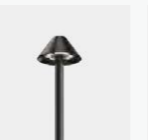

FAIRY



CRANE

3 Architectural & Decorative Lighting



FLEX

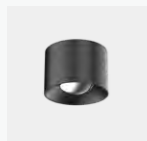

ORBIT

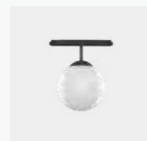

FINO

4 North American Market Range



LX26



LINK30



LINK60



QUICK50

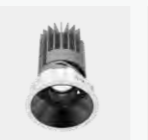

START

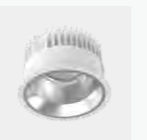

DOME



VTRIM



LEDGO

INDOOR LIGHTING

■ High-Efficacy Commercial Lighting

LUCIA/LINK60/TESLA ----- 04-06

■ Architectural & Technical Lighting

START/LEDGO/LINK30/FLATIA ----- 08-11

■ Commercial Lighting

CREST/LUMI/LINK60/DOME/BINGO/NOVA ----- 13-16

■ Residential Lighting

VTRIM/DOT/LX26/LX19/LX10/SKYLINE ----- 18-24

LUCIA >120lm/W

- Round aluminum housing ensures the optimal cooling of the LEDs
- Available in standard version
- Suitable for ceiling-mounted, wall-mounted suspended installation
- 4 diameters for options (350 mm, 450 mm, 600 mm, 900 mm)
- Microprismatic cover for super eye comfort
- IP40 Rated

>120lm/W



Microprismatic
super eye comfort
UGR<19

Direct Lighting



LUCIA 350
14W 1800lm
18W 2200lm



LUCIA 450
18W 2500lm
25W 3300lm



LUCIA 600
40W 5200lm
48W 6600lm



LUCIA 900
62W 8400lm

In-direct Lighting module optional

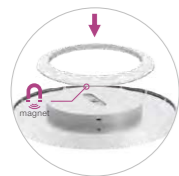

In-direct module
easy to install by magnet



CCT DIP switch version optional
3000K-3500K-4000K

Housing



white black

Illumination Type

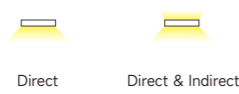

Direct Direct & Indirect

Installation

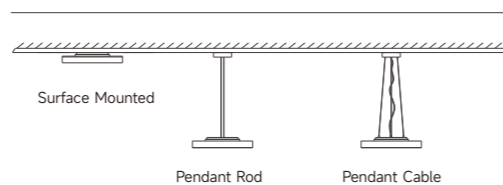

Surface Mounted

Pendant Rod

Pendant Cable

LINK60 >120lm/W

Linear Lighting System

- UGR<19
- High efficacy
- Quick installation
- Suspended / Surface / Recessed Mounting
- White / Black color



Microprismatic
super eye comfort
UGR<19

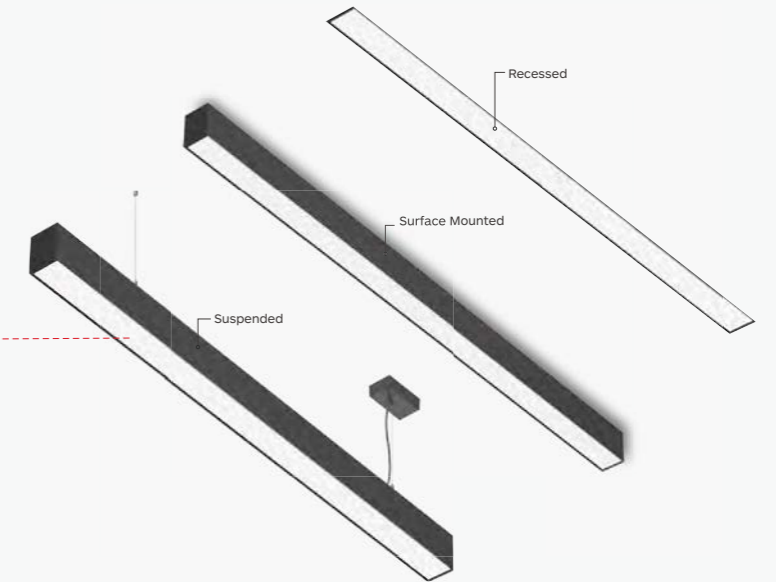

LINK 60-DL
25W 2600lm
33W 3300lm
38W 3800lm

LINK 60-UL (High Efficiency)
21W+17W 4900lm
26W+21W 6100lm

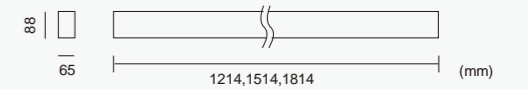

Ultra-long flexible diffuser

Up to 30m long without light leakage.
Microprism craftsmanship, uniform and soft light.

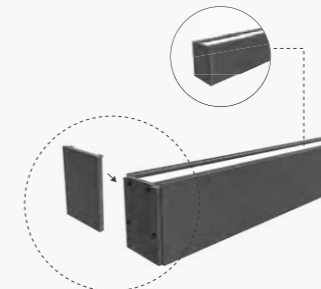

No light leakage

Double end cap design without
light leakage and visible screws.
Easy disassembly for continuous
connection.



Surface mounted accessories

Rotary clip design for convenient
installation.



Connection accessories

Four kinds of corner,
No need complex cutting.

TESLA >120lm/W

- TESLA is a series of compact downlight, which keep a excellent balance between super light confort and high efficacy. UGR<19 and 120 lm/W at the same time. 30° shielding angle
- The light source is deeply integrated for glare control.
- The product is efficient at various heights, available with different lumen pack-ages and beam angles.
- High-flux PCB LED modules, mid-power SMD LED.
- Imported PMMA diffuser improves the higher efficiency and less glare value.
- Polycarbonate reflector with inner vacuum plating surface and die-cast aluminum heat sink.

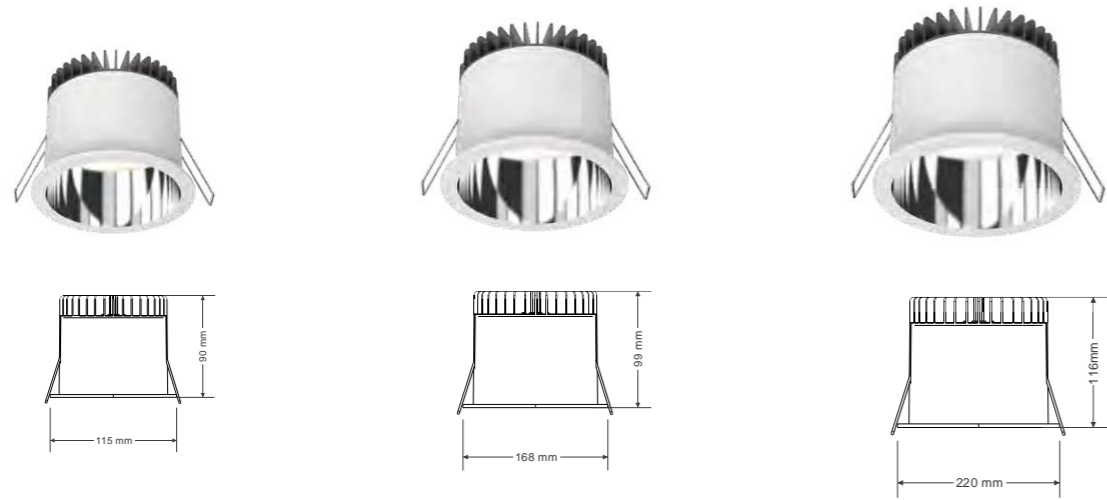

TS4

60°
8W 1190Lm
11W 1670Lm

TS6

60°
12W 1760Lm
18W 2650Lm
24W 3280Lm

TS8

60°
25W 3480Lm
30W 4100Lm



ARCHITECTURAL &
TECHNICAL LIGHTING

Architectural Downlight

- One light engine with various accessories
- Easy to specify
- Easy to manage stock
- Easy to install and adjust
- Easy to change reflector

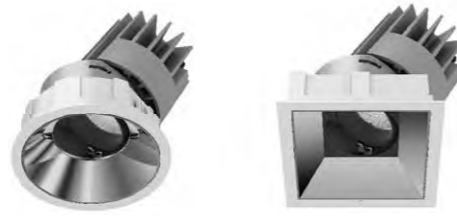

Start45	Start68	Start100	Start125	Start150
Φ45mm 4W 380lm	Φ68mm 7.5W 750lm 11W 950lm	Φ100mm 13W 1600lm 18W 1900lm 25W 2600lm	Φ125mm 18W 1700lm 25W 2400lm	Φ150mm 25W 2600lm 38W 3500lm

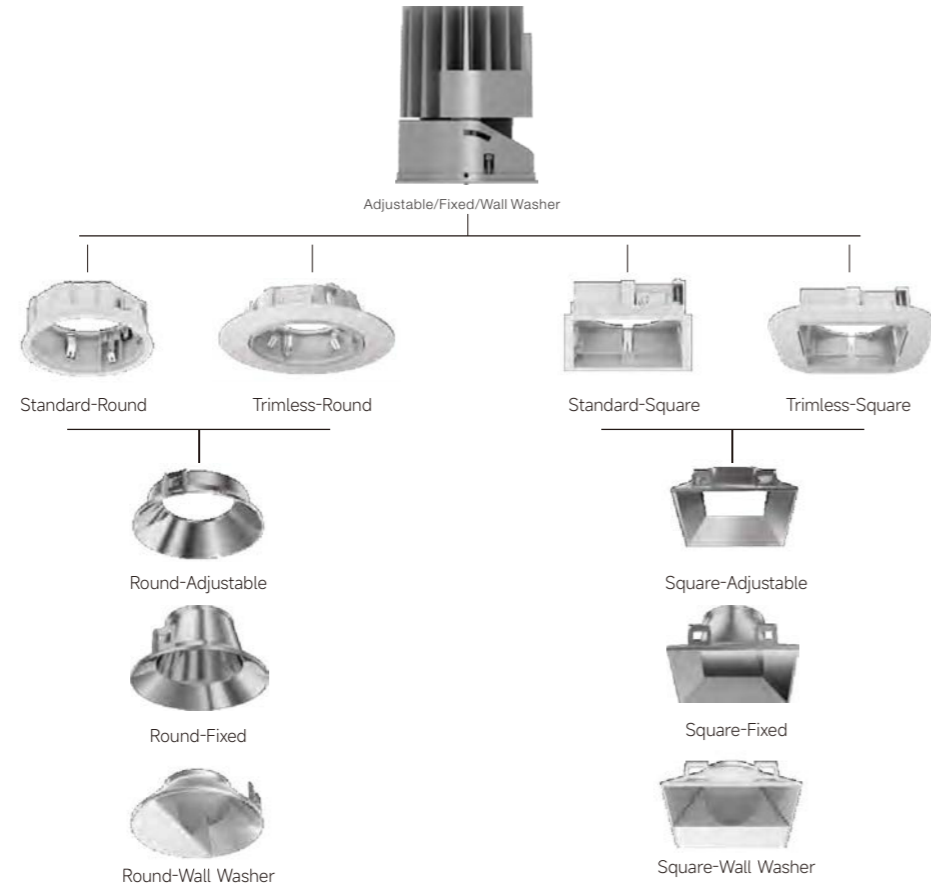

Interchangeable secondary-reflector, Various colors for options

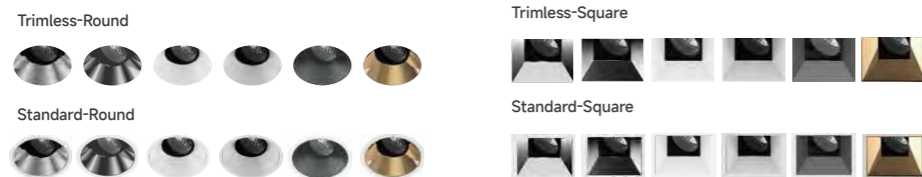

LED Linear Downlight

- Ultra Miniature Design
- Multiple Spotlight
- Super Eye Comfort UGR < 19
- Interchangeable Secondary- Reflector with Different Colors



Fixed

37mm 2W 180Lm	62mm 4W 350Lm	90mm 7W 550Lm	65x65mm 9W 700Lm	144mm 13W 850Lm	282mm 22W 1700Lm

Adjustable

144mm 9W 650Lm	282mm 17W 1300Lm	160mm 11W 850Lm	298mm 22W 1700Lm

Wallwasher

144mm 11W 550Lm	282mm 22W 1100Lm

Trimless

154mm 13W 850Lm	292mm 22W 1700Lm	154mm 9W 650Lm	292mm 17W 1300Lm	154mm 11W 550Lm	292mm 22W 1100Lm

Secondary reflector

Colour

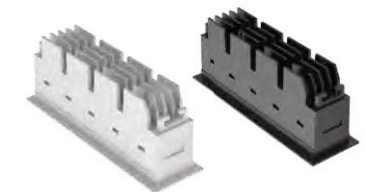

LINK30

Linear Lighting System

Extremely Compact Linear Light UGR<16

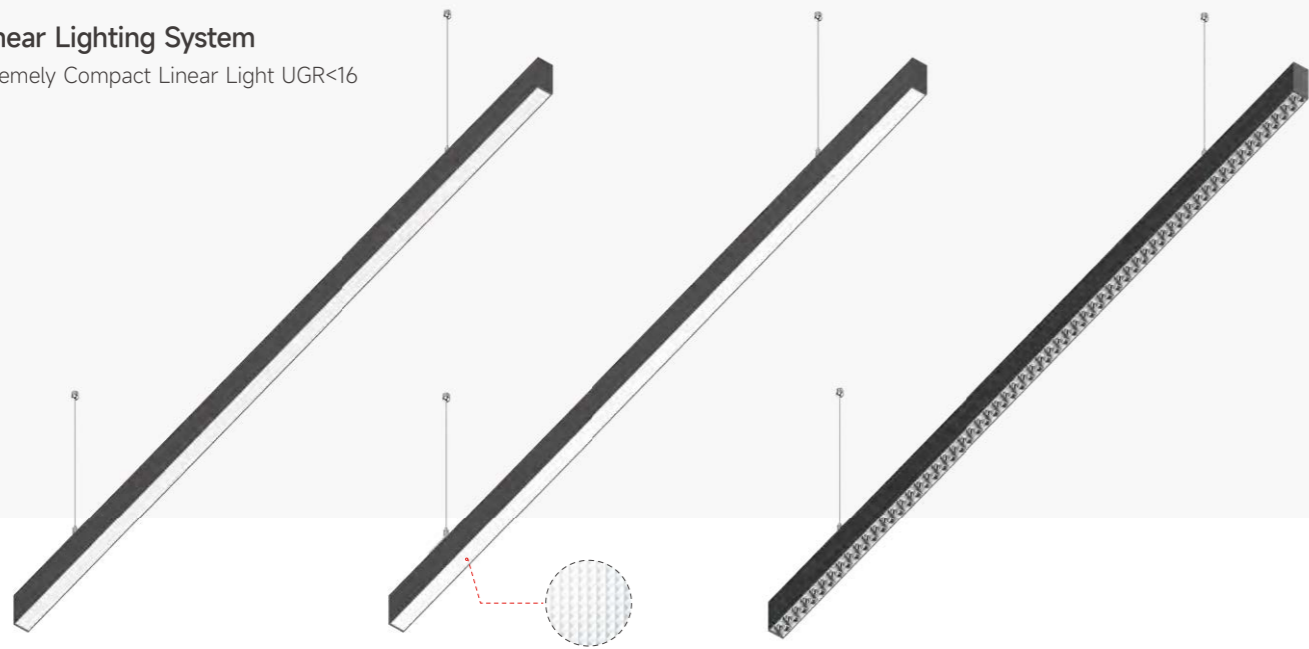

General Light

Comfort Light

Accent Light

GL Fixture

1060MM Direct output: 2400lm Indirect output : 1100 lm System Power: 36W
 1590MM Direct output: 4000lm Indirect output : 1600 lm System Power: 56W

CL Fixture

1060MM Direct output: 2200lm Indirect output : 1700 lm System Power: 36W
 1590MM Direct output: 3600lm Indirect output : 1600 lm System Power: 54W

AL Fixture

1060MM Direct output: 2700lm Indirect output : 1100 lm System Power: 36W
 1590MM Direct output: 4100lm Indirect output : 1600 lm System Power: 54W

LUMINOUS INTENSITY DISTRIBUTION DIAGRAM

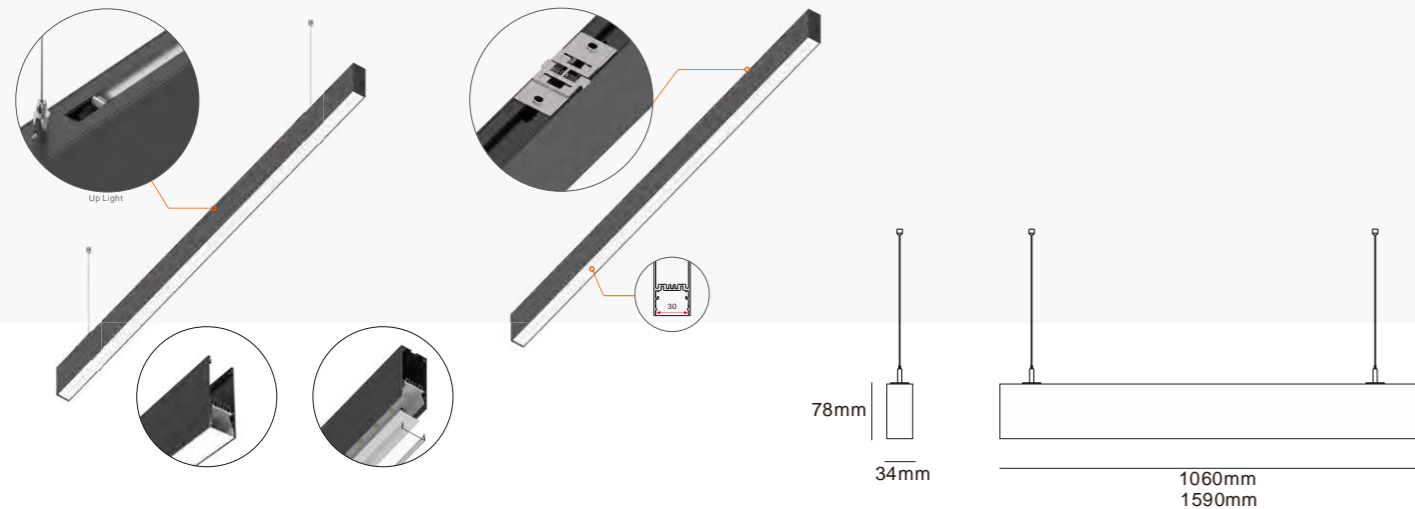
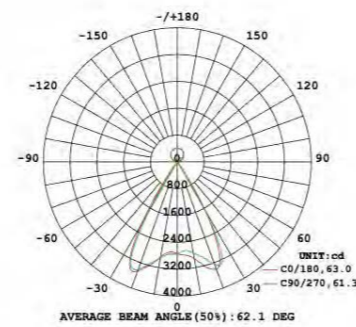

FLATIA

- Microprism diffuser, UGR<19
- Modular design
- Easy for assembly, stock management and quick ship
- Magnetic uplight to fit the needs and style of space
- IP40 Rated



Size	Power	Direct Output (lm)	Indirect Output (lm)
350mm	14W	1500lm	18W 2200lm
450mm	18W	2200lm	26W 3000lm
600mm	40W	5000lm	50W 6500lm
900mm	68W	8500lm	

Ceiling Box with Suspension Rod Ceiling Box with Suspension Wires

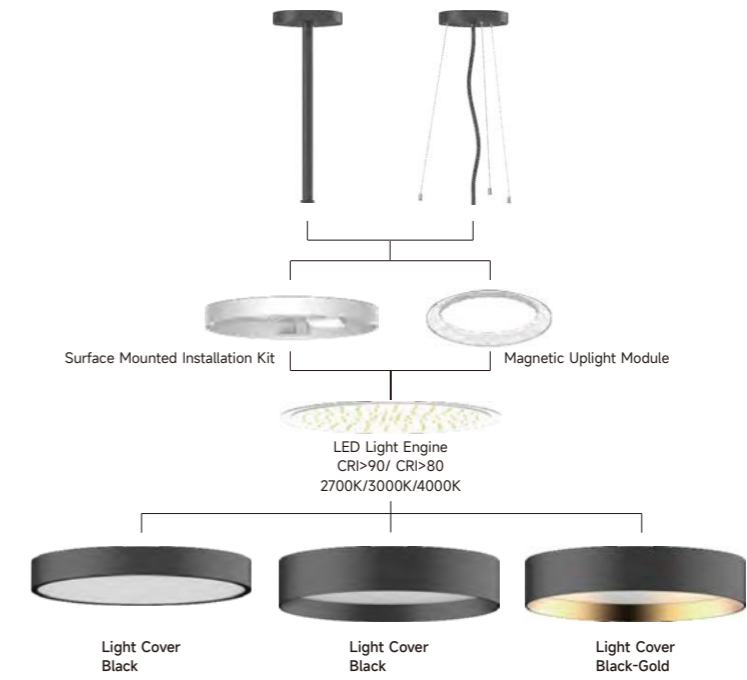

Housing:



Installation:

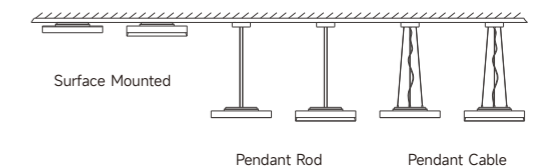

Edge-lit



CREST

Back-lit



LUMI

COMMERCIAL LIGHTING

CREST

- Round fixture with a microprismatic diffuser is ideal for workstations.
- CREST's innovative technology make it flat and minimalistic design.
- It integrated multiple installation options and dimming modes.
- The surface mounted and suspended fixture come with loop in & loop out design, easy installation.



Surface mounted

CREST400
Φ400mm
26W 2300Lm



Suspended



Easy Installation

Twist and lock design
Loop in & loop out wiring design



Emergency back-up

(optional)



CCT Switch Selectable

CCT:3000K/3500K/4000K



UGR<19

Microprism craftsmanship,
uniform and soft light.



Microwave Sensor +CCT

LUMI

- Lumi is Lucia's little sister, more cost effective.
- Back-lit ceiling light with height of 65mm suitable for almost everywhere.
- Microprismatic optic contributes to high visual comfort.
- Surface-mounted, pendant optional.



Surface mounted



Suspended



LUMI 300

Φ300mm

9W 1030lm

13W 1400lm



LUMI 400

Φ400mm

18W 2200Lm

26W 2700Lm



LUMI 600

Φ600mm

45W 4900Lm

DOME

- Available in cutout sizes of 75, 100, 150 and 200mm in round and square shapes.
- Up to 120 lumens per watt, IP54 rated.
- Deep recessed design achieves super eye comfort, UGR value <19
- Modular design make the heatsink, optical components, secondary reflectors can be ordered separately and low inventory pressure.
- Interchangeable reflector including Matt, white, black color options.



D75 7.5W 750 lm 11W 950 lm	D100 8.5W 1200Lm 12W 1600Lm	D150 17W 2300Lm 24W 3100Lm	D200 24W 3300Lm 36W 4800Lm 51W 5600Lm
---	--	---	---

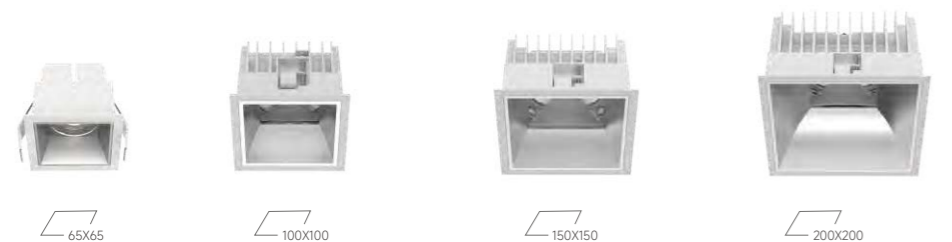

DS65 7.5W 750 lm 11W 950 lm	DS100 8.5W 1000lm 12W 1400 lm	DS150 17W 2050 lm 24W 2800 lm	DS200 24W 2800 lm 36W 3900 lm
--	--	--	--

Creative Ceiling Treatment

Suitable for 1-25mm thickness ceiling board.

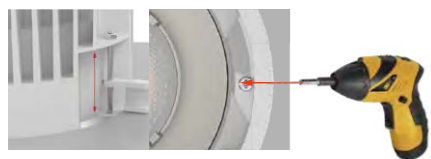

Interchangeable reflector

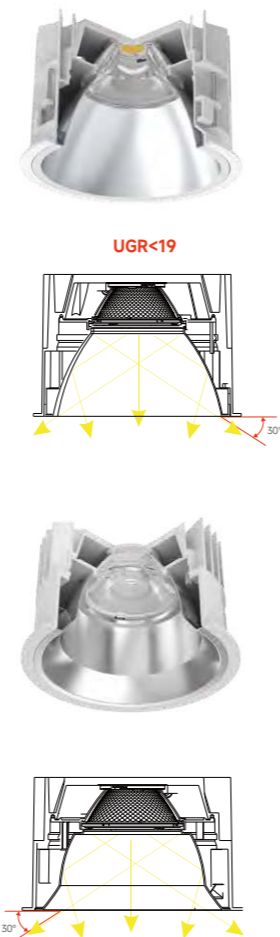

BINGO & BINGO PRO

- Concise structure with in-track LED driver
- Optical choices in fixed or adjustable lens

BINGO



BINGO S

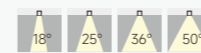

15W 1000lm

BINGO M

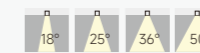

15W 1300lm
21W 1700lm

BINGO K

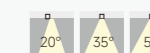

28W 2400lm

BINGO PRO



BINGO PRO

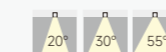

21W 1600lm

Adjustable

horizontal rotation 0~355°, vertical tilt 0~90°.



Small size but high power

Benefiting from external power supply and excellent heatsink design, BINGO PRO series with $\Phi 53\text{mm}$ can achieve the same heat dissipation effect of conventional products with $\Phi 70\text{mm}$ on the market.



NOVA

Ceiling Mounted & Pendant Light

- Modern aesthetic Ceiling & Pendant light
- Engineering to combine maximum performance with a sleek style
- No visible screw, more elegant

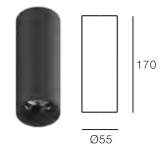
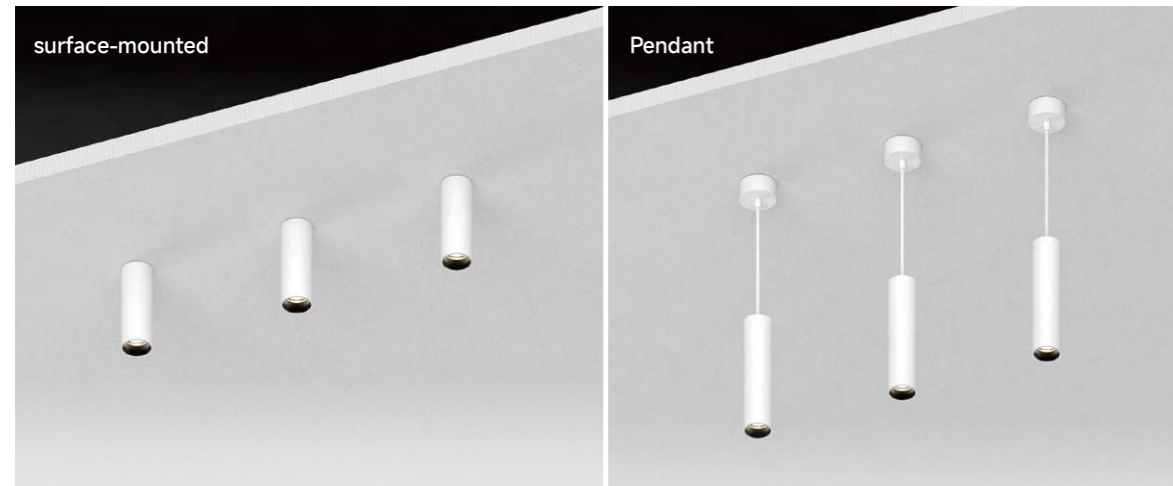

NOVA-C S
11W 720lm-800lm

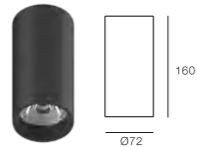

NOVA-C M
15W 1300lm
21W 1700lm

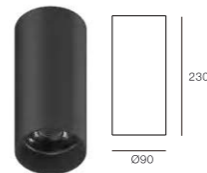

NOVA-C L
28W 2900lm

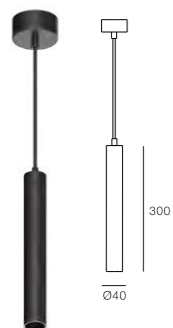

NOVA-P XS
11W 800lm

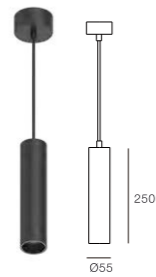

NOVA-P S
11W 800lm

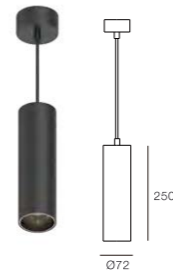

NOVA-P M
15W 1300lm
21W 1700lm

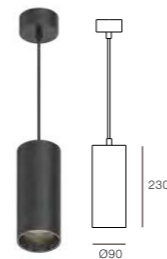

NOVA-P L
28W 2900lm

Decoration ring



Black White Gold



RESIDENTIAL LIGHTING

VTRIM

- Perfect choice for specified architectural projects
- Compatible with LED Modules
- Wide range of design variants for different applications
- Available in trimless version
- Decorative rings painted in a variety of colors (black, white, marble, wood, etc.)
- Magnetic design for changing decorative ring without any tools

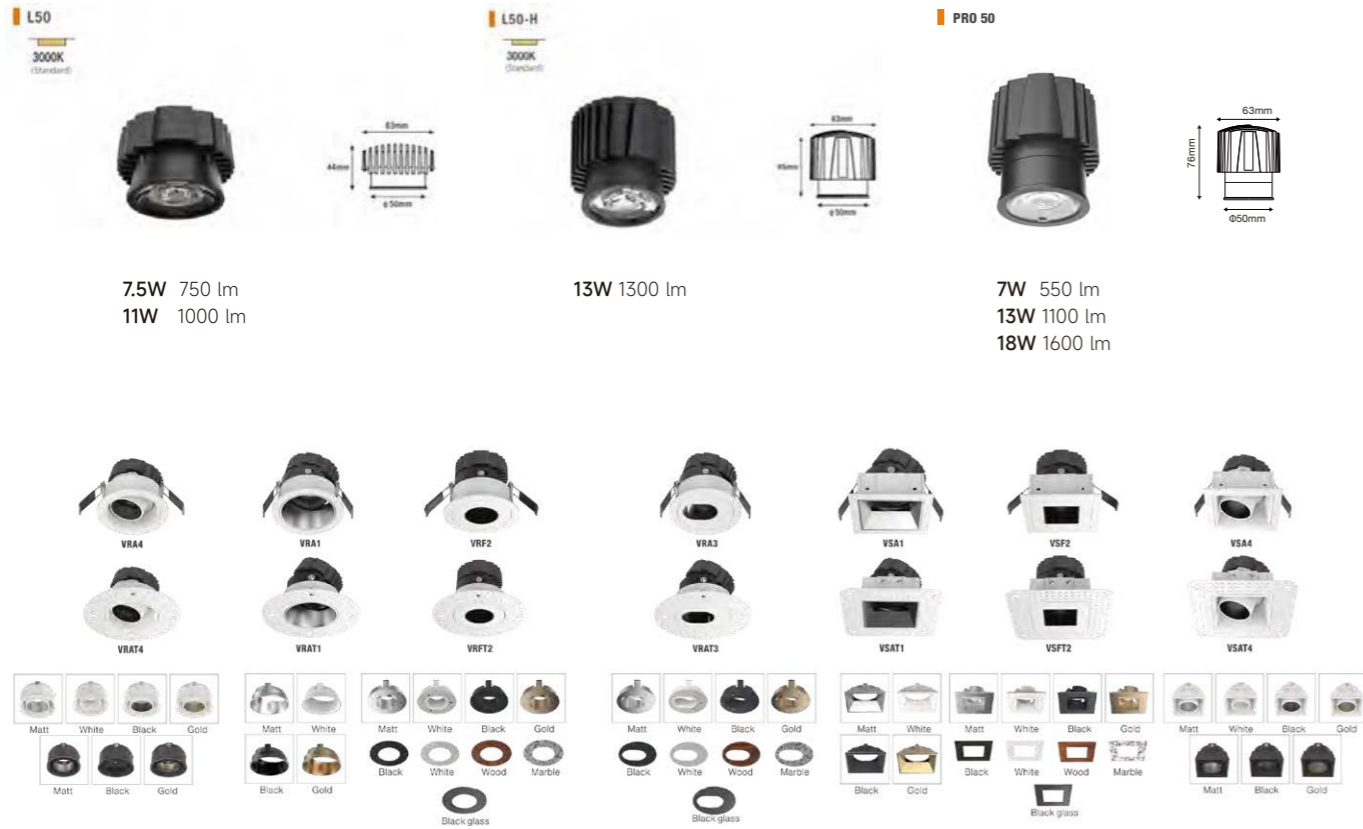

PRO 50

LED Power: 7W/ 9W/ 13W/ 18W
 LED Chip: Bridgelux CRI>97, R9=95, 2-step SDCM
 Beam Angle: 10°/ 15°/ 25°/ 35°/ 50°
 Standard CCT: 2700K/ 3000K/ 3500K/ 4000K
 Optional CCT: 1800K-3000K Warm Dim/ 2700K-6500K Tunable White

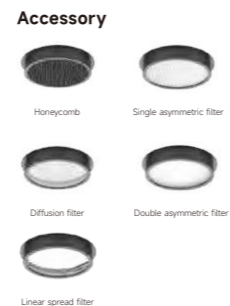
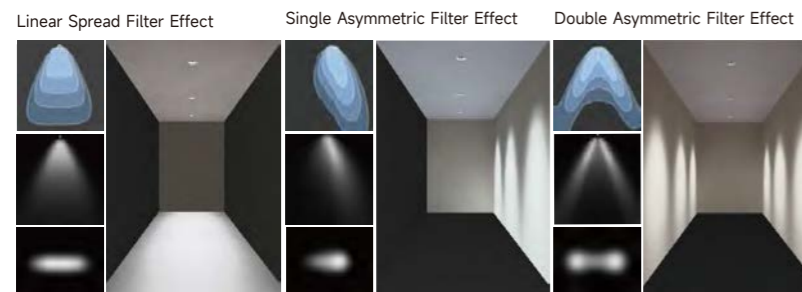

DOT

Minimal LED Downlight

- Minimalistic design with cutout of 35mm,45mm.
- Deep recessed , soft curved design
- Complete glare control & visual comfort, UGR<16
- Tool free change lens and boards
- Super easy installation

DOT-G

DOT-H



DOT-G

Economic Version



DOT-H

Premium version with different decorative inner rings



LINEX 26

DC48V Track

- An innovative and dynamic track lighting system.
- Lock system for safety

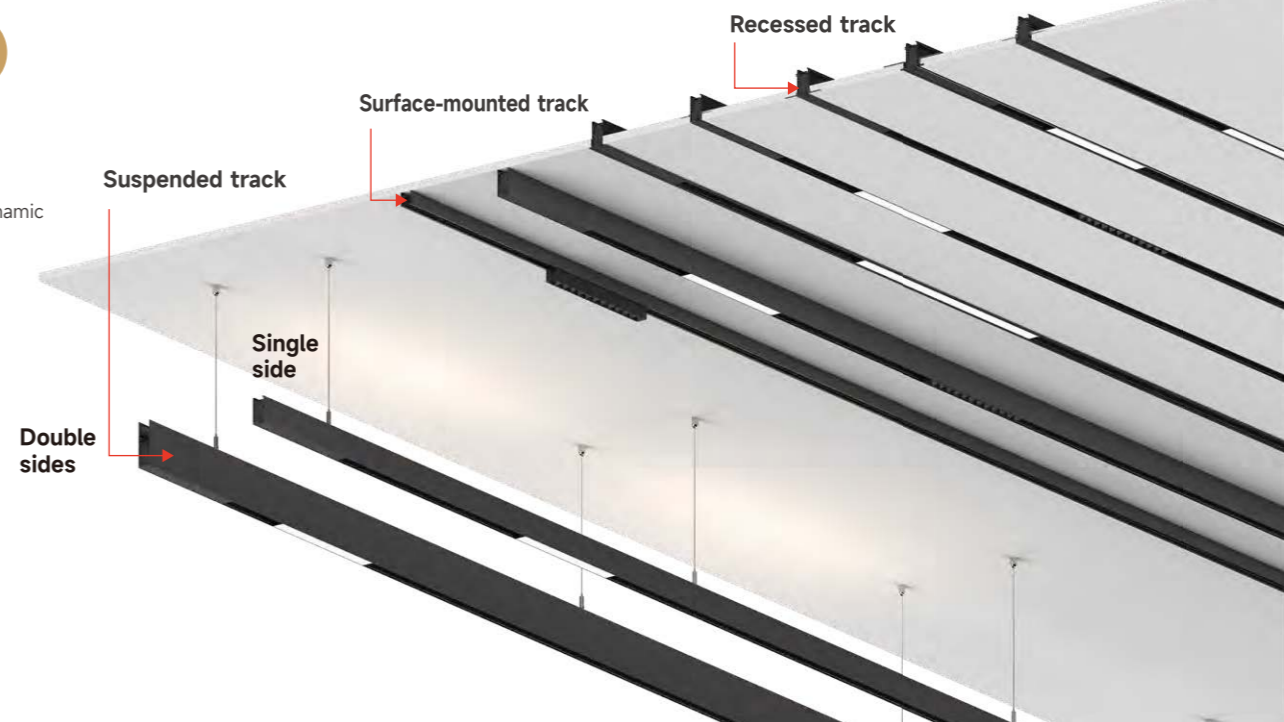

Surface-mounted track

Suspended track

Recessed track

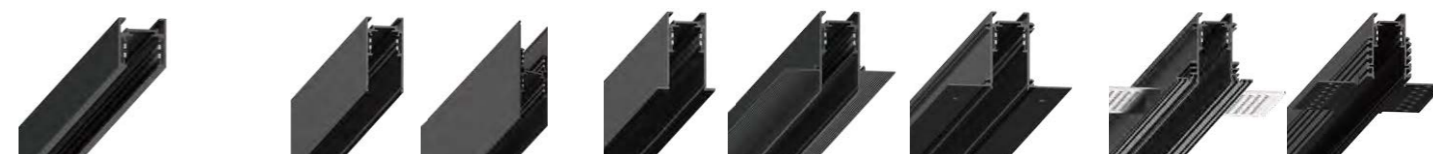

Inserts for track

Spotlight insert



Accent light insert



General light insert



Downlight insert



Comfort light insert



Decorative light insert

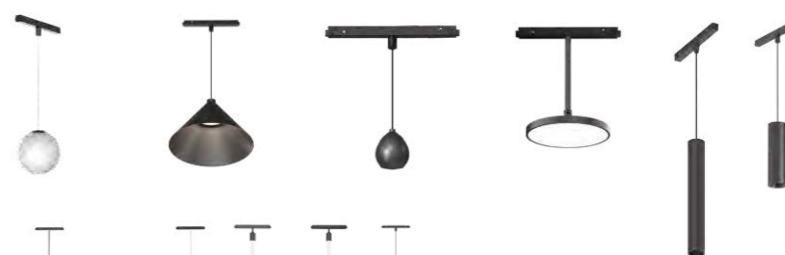

Wall washer insert



LOW VOLTAGE TRACK SYSTEM



LINE X19



DC24V Track

- Extruded aluminum profile with 19mm width groove. 24VDC Version
- Good application for residential lighting projects
- Available for Triac-dimming

LINE X10



DC24V Track

- Thin extruded aluminum profile with 10mm width groove. 24VDC Version
- Good application for residential lighting projects
- Available for Triac-dimming

Surface-mounted Track



Surface-mounted Track (Standard track)



Suspended Track



Recessed Track (Trimless, Easy installation)



Recessed Track



Recessed Track (With trim)



Accent Light LED Strip



General Light LED Strip



Inserts for track

Spotlight Insert



Spotlight Insert



Core



Core+Cover



Inserts for track

Spotlight Insert



Spotlight Insert



General Light LED Strip



Accessories



SKYLINE

DC24V

- Discover a new level of freedom of light
- Be evolved with a functional network
- Having a creative and fun concept

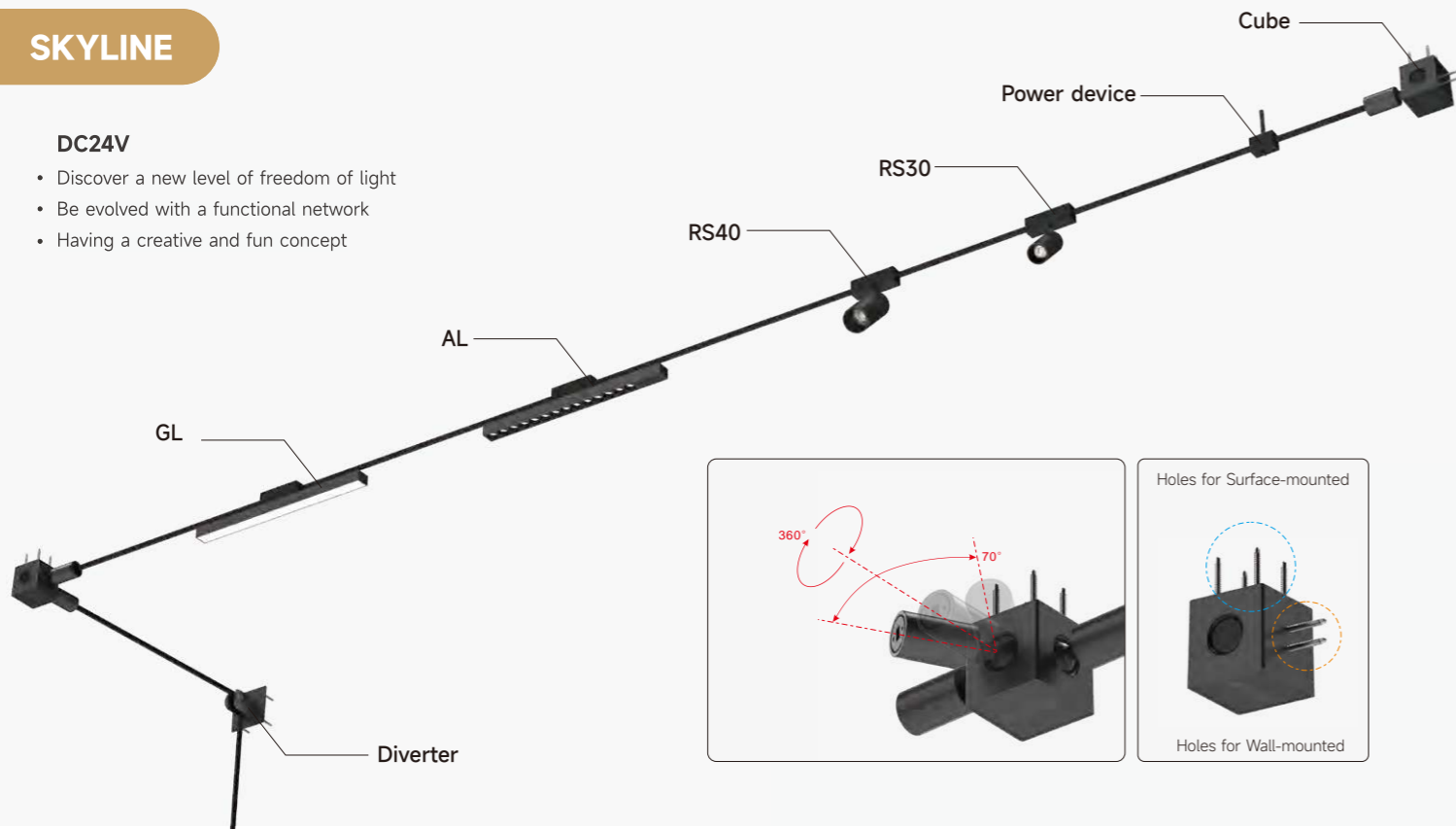

Inserts for track

Accent light insert



General light insert



Spotlight Insert



Spotlight Insert



Accessories



Diverter

Tensioner

Cube

Power device

Cable

2 OUTDOOR LIGHTING

EPO /EOS/FOCAL -----	26
DORI & SOLAR -----	27
PLUTO -----	28
SWAMM -----	31
FAIRY A/B/C -----	32
CRANE -----	34

Inground Light / Projector Light

- Triple layer coating for high resistance to corrosion: chemical conversion coating on the aluminium surface followed by a firstlayer of anodising, a second layer of epoxy power and a third finishing layer of polyester powder.
- Corrosion tests in artificial atmospheres
- Salt spray test passed at 1000hrs.



EPO NANO-V1 CV Inground Light Top Cover Stainless Steel 316 Anodized aluminium body Input 12-24VDC IP67 Power 3W	EPO NANO-V2 CV Inground Light Top Cover Stainless Steel 316 Anodized aluminium body Input 12-24VDC IP67 Power 3W	FOCAL-R CV Inground Light Top Cover Stainless Steel 316 Anodized aluminium body Input 20-24VDC IP67 15° 25° 40° Power 2W	FOCAL-S CV Inground Light Top Cover Stainless Steel 316 Anodized aluminium body Input 20-24VDC IP67 15° 25° 40° Power 2W
EPO NANO CV Inground Light Top Cover Stainless Steel 316 Anodized aluminium body Input 12-24VDC IP67 Power 3W	EPO MINI CV Inground Light Top Cover Stainless Steel 316 Anodized aluminium body Input 12-24VDC IP67 15° 25° 40° 60° Power 4.8W	EPO MAXI CV Inground Light Top Cover Stainless Steel 316 Anodized aluminium body Input 20-24VDC IP67 15° 20° 30° 60° Power 11.5W	
EOS NANO CV Outdoor Projector Light Anodized aluminium body Input 12-24VDC IP67 15° 25° 40° Power 3W	EOS MINI CV Outdoor Projector Light Anodized aluminium body Triple layer coating Input 12-24VDC IP67 15° 20° 30° 60° Power 4.8W	EOS MAXI S316 CV Outdoor Projector Light Stainless Steel 316 body Input 20-24VDC IP67 15° 20° 30° 60° Power 11.5W	

Accessory: Spike for outdoor projector light



IP67 Outdoor Lighting Inground Light / Projector Light

- Triple layer coating for high resistance to corrosion: chemical conversion coating on the aluminium surface followed by a firstlayer of anodising, a second layer of epoxy power and a third finishing layer of polyester powder.
- Corrosion tests in artificial atmospheres
- Salt spray test passed at 1000hrs.



DORI Micro Inground Light Top Cover Stainless Steel 316 Anodized aluminium body Input 12-24VDC IP67 Power 1.5W	DORI Nano Inground Light Top Cover Stainless Steel 316 Anodized aluminium body Input 12-24VDC IP67 Power 1.5W	DORI Mini Inground Light Top Cover Stainless Steel 316 Anodized aluminium body Input 12-24VDC IP67 Power 5.5W	DORI Mini V1 Inground Light Top Cover Stainless Steel 316 Anodized aluminium body Input 12-24VDC IP67 Power 5.5W
DORI Mini V2 Inground Light Top Cover Stainless Steel 316 Anodized aluminium body Input 12-24VDC IP67 Power 5.5W	DORI Maxi Inground Light Top Cover Stainless Steel 316 Anodized aluminium body Input 12-24VDC IP67 Power 10W	DORI Maxi V1 Inground Light Top Cover Stainless Steel 316 Anodized aluminium body Input 12-24VDC IP67 Power 10W	DORI Maxi V2 Inground Light Top Cover Stainless Steel 316 Anodized aluminium body Input 12-24VDC IP67 Power 10W
DORI Maxi V4 Inground Light Top Cover Stainless Steel 316 Anodized aluminium body Input 12-24VDC IP67 Power 10W	SOLAR Mini Outdoor Projector Light Anodized aluminium body Triple layer coating Input 12-24VDC IP67 Power 5.5W	SOLAR Maxi Outdoor Projector Light Anodized aluminium body Triple layer coating Input 12-24VDC IP67 Power 10W	

Accessory: Spike for outdoor projector light



Pluto Family

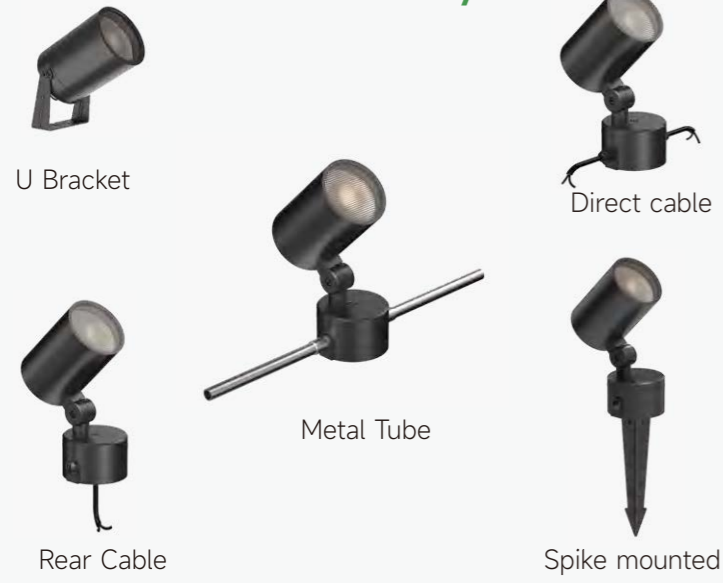

- Typically weather-resistant and durable design, making PLUTO perfect for use in a variety of outdoor settings.
 - Compact and aesthetic appearance, highlighting residential and architectural features of buildings or landscapes.
- 10° / 24° / 35° / 55°
 3W / 5W / 12W / 18W
 Ceiling, Wall ground, Spike or Tree



90° vertical and 360° horizontal adjustment via unique swivel stem and rotatable base design.

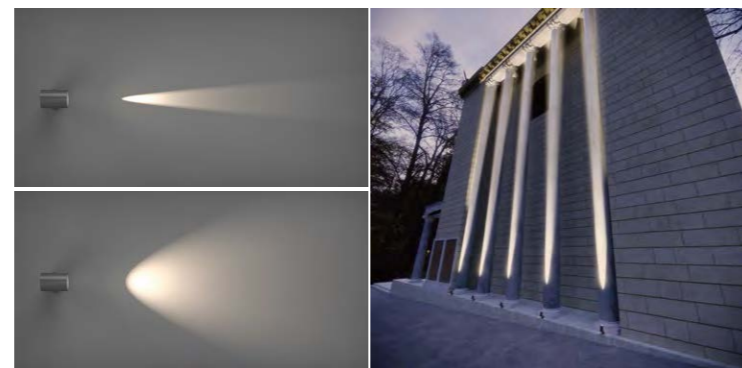

Beam angles vary from 10° to 55°

U Bracket



Metal Tube

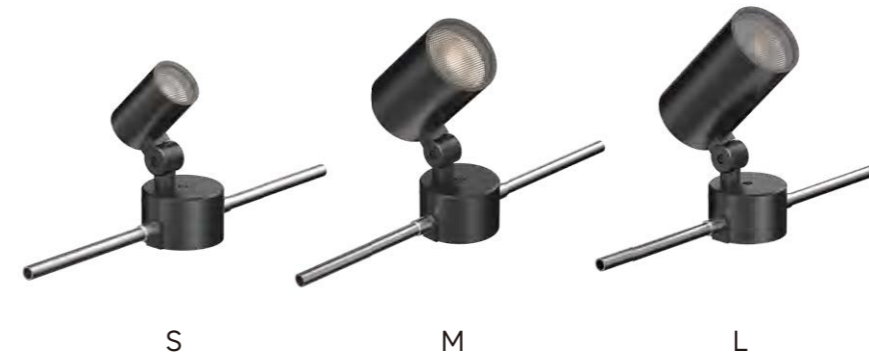

Rear Cable



Spike mounted

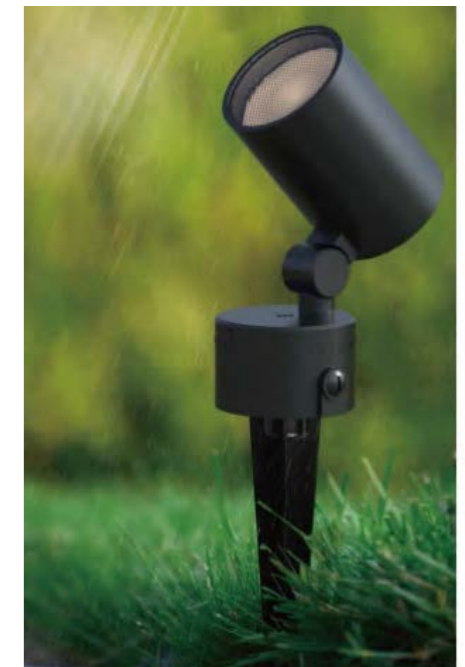

PLUTO ART



SWAMM-S50,S100

- Delicate and enchanting addition to the gardens.
- Soft glow illuminates the surrounding flora, casting a warm and inviting ambiance.

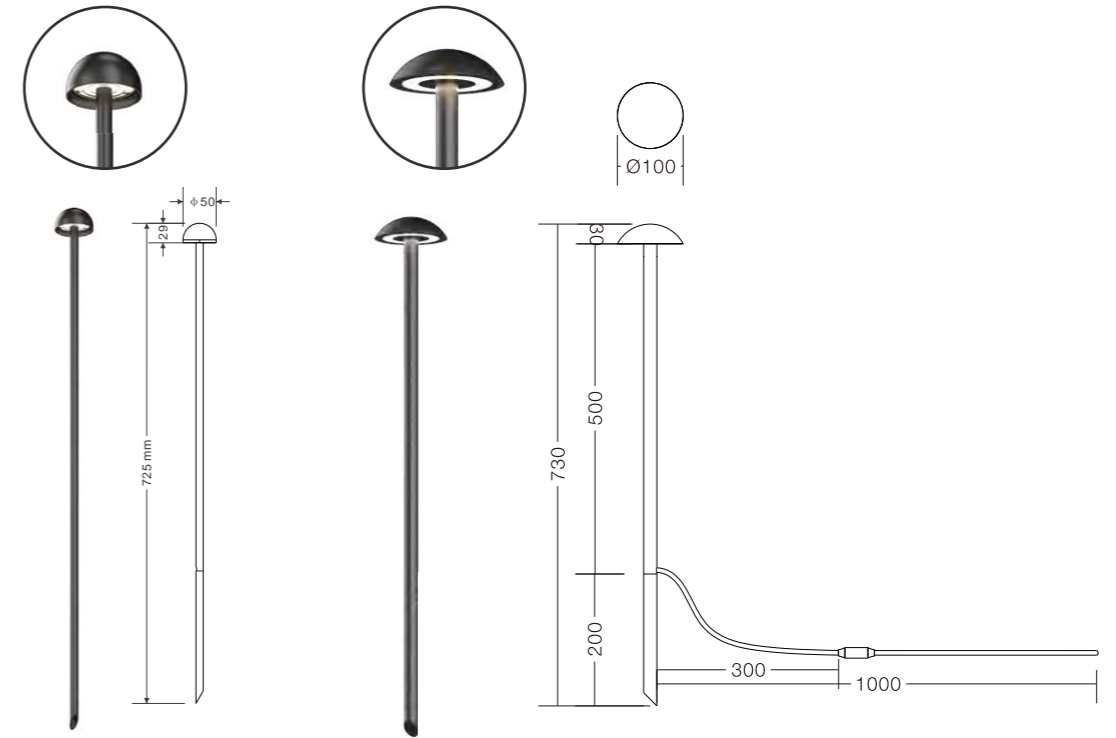

SWAMM-S50
2W 90Lm

SWAMM-S100
2W 90Lm

SWAMM-S50 & SWAMM-S100



FAIRY A/B/C

- Wide light spot achieved by advanced lens design
- IP66 waterproof design, perfect for outdoor use
- Triple layer coating, ensuring over 1000 hours of salt mist test, suitable for seaside installations
- 5 years warranty

FAIRY A/B/C
6W
 400Lm/2200K
 500Lm/3000K

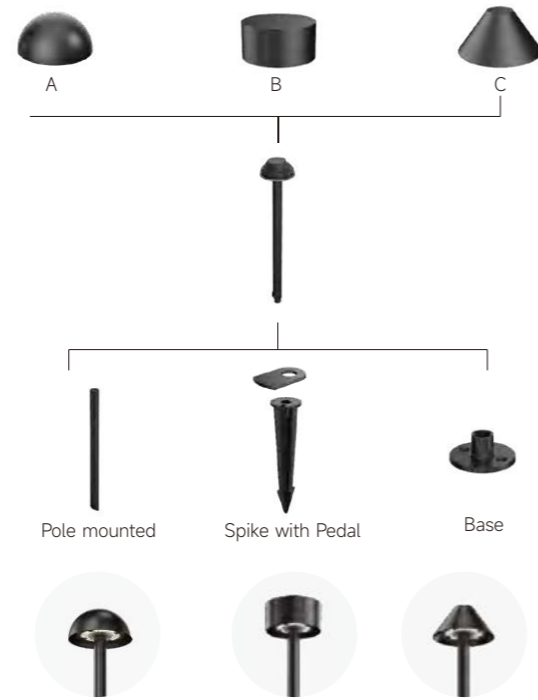

- Covers are interchangeable

- Press button for CCT changeable



- Extension poles with easy electrical connection

- Multiple installation accessories

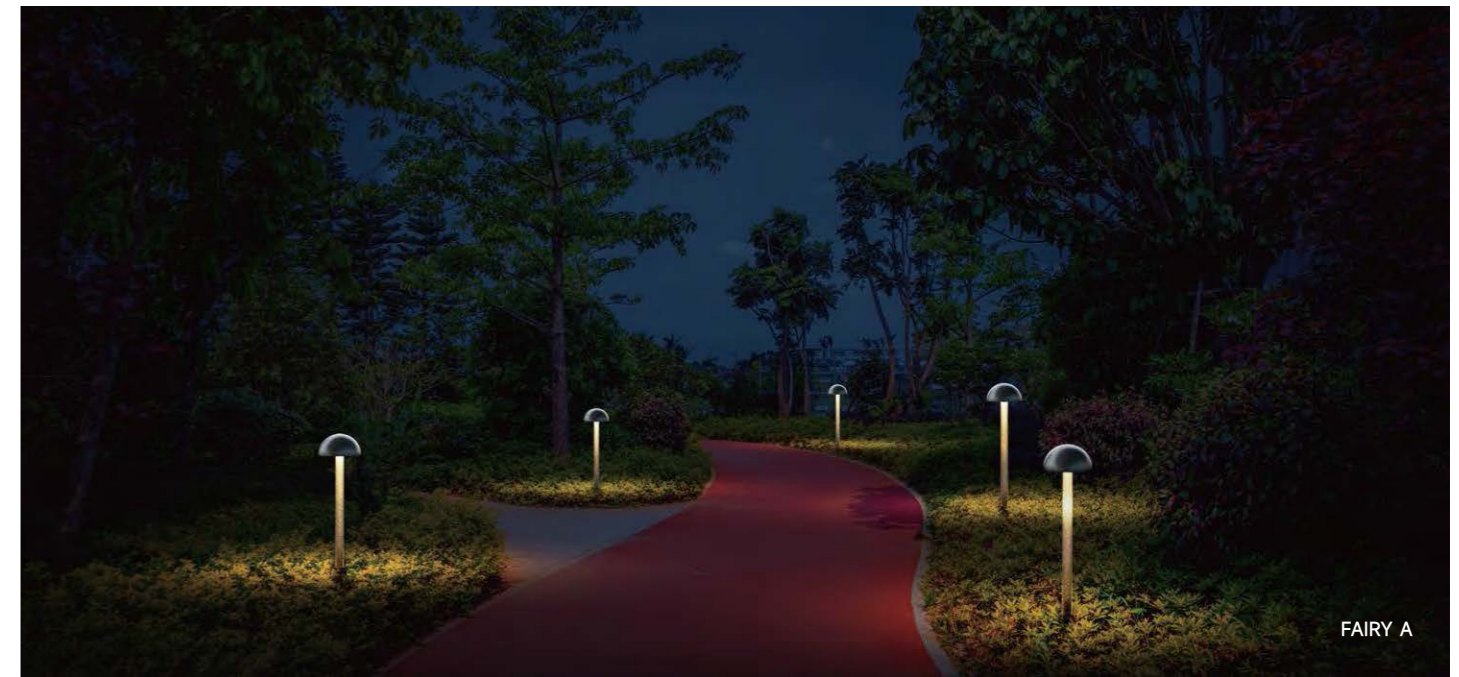

FAIRY A

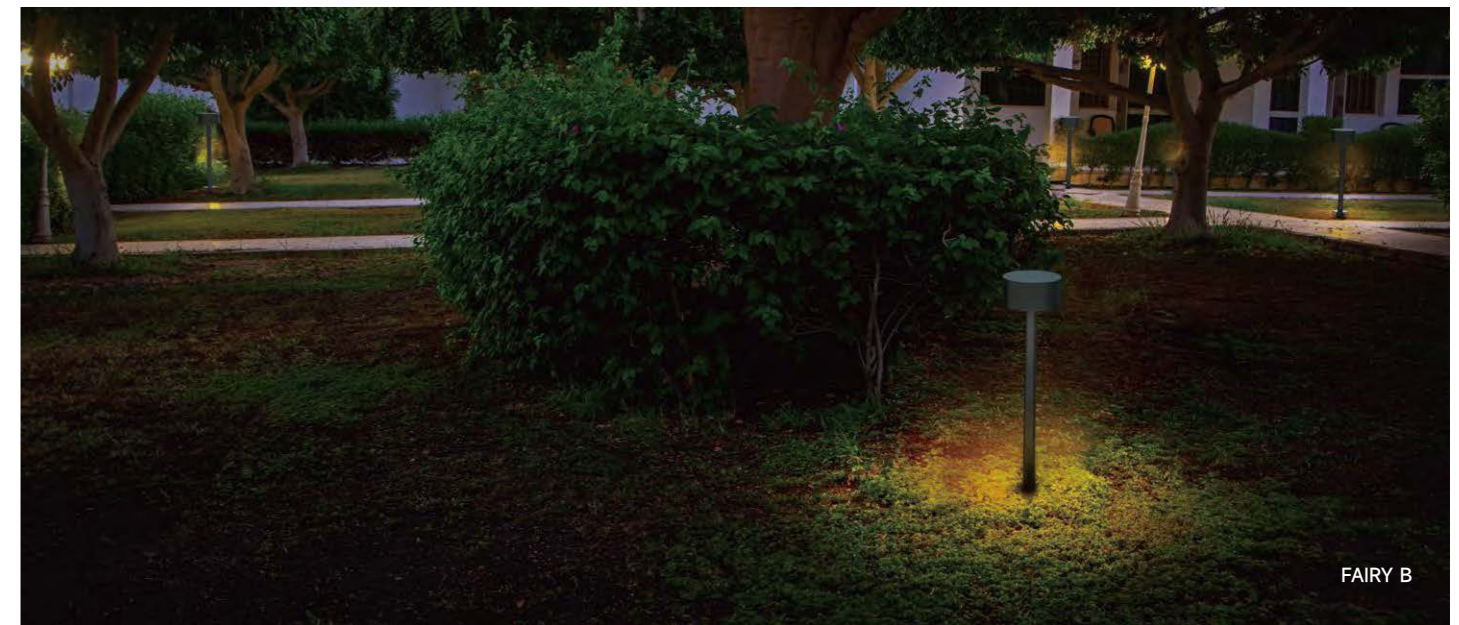

FAIRY B



FAIRY C

CRANE

- As the sun sets and the garden fades into darkness, CRANE becomes a beacon of beauty, guiding the way and adding a touch of magic to the night.

CRANE
3W 90Lm

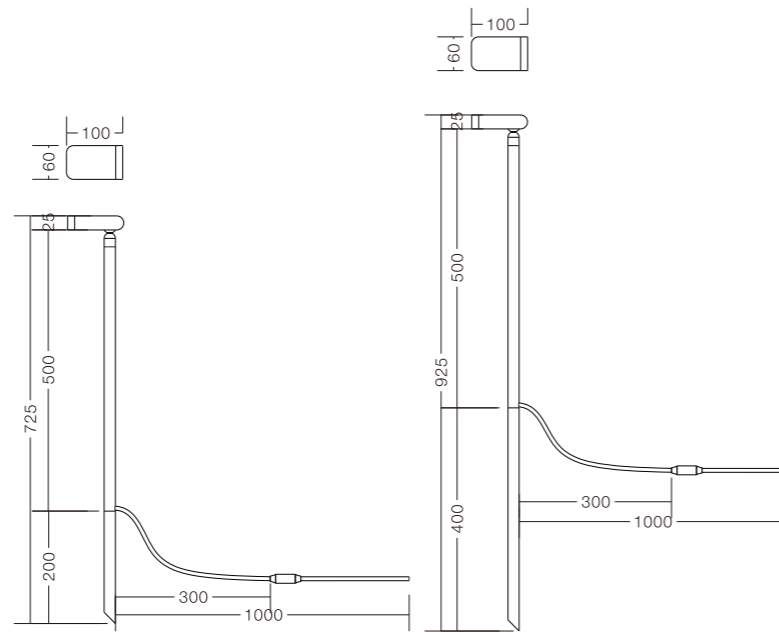

ARCHITECTURAL DECORATIVE LIGHTING

FLEX ----- 37

ORBIT ----- 38

FINO ----- 39

FLEX

Voltage: 24VDC
 Maximum length: 5 meters
 Wattage: 14.5W/M
 Dimension: 23mm
 Output lumen:
 1000lm/m , Φ 23mm
 for CRI90 3000K
 Light distribution: 360°



- Illuminate your space with flexibility
- 360° circular lighting neon strip
- Creative design and Casual combination

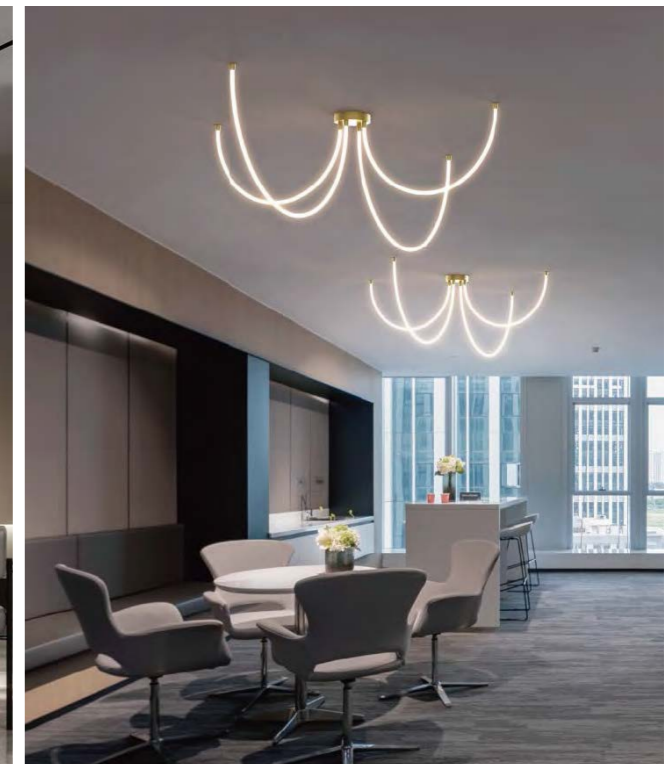

ORBIT

- Light up your world with Orbit
- Simplicity is the ultimate sophistication
- Pure lines and Essential geometry

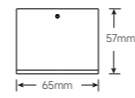
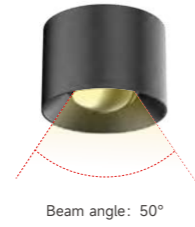

ORBIT-S
4W 260lm

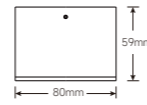

ORBIT-M
8W 490lm



FINO

- Finely crafted lights for a polished look
- Four aesthetic colors
- Three various sizes



LED W	System W	System LM	CRI	CCT	Beam	Size
4W	5W	230lm	>90	3000K	180°	Φ120
4W	5W	260lm	>90	4000K	180°	Φ120
6W	7W	330lm	>90	3000K	180°	Φ150
6W	7W	380lm	>90	4000K	180°	Φ150
8W	10W	450lm	>90	3000K	180°	Φ200
8W	10W	500lm	>90	4000K	180°	Φ200

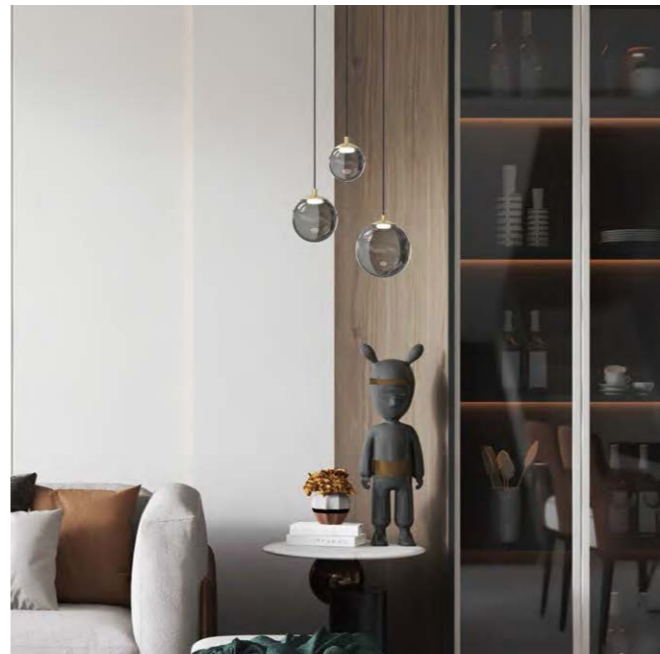

NORTH AMERICAN MARKET RANGE



LX26	-----	41
LINK30	-----	42
LINK60	-----	43
QUICK 50	-----	44
START	-----	45
DOME	-----	46
VTRIM	-----	47
LEDGO	-----	48

LINEX 26

DC48V Track

- An innovative and dynamic track lighting system designed for quick and easy repositioning of lock system

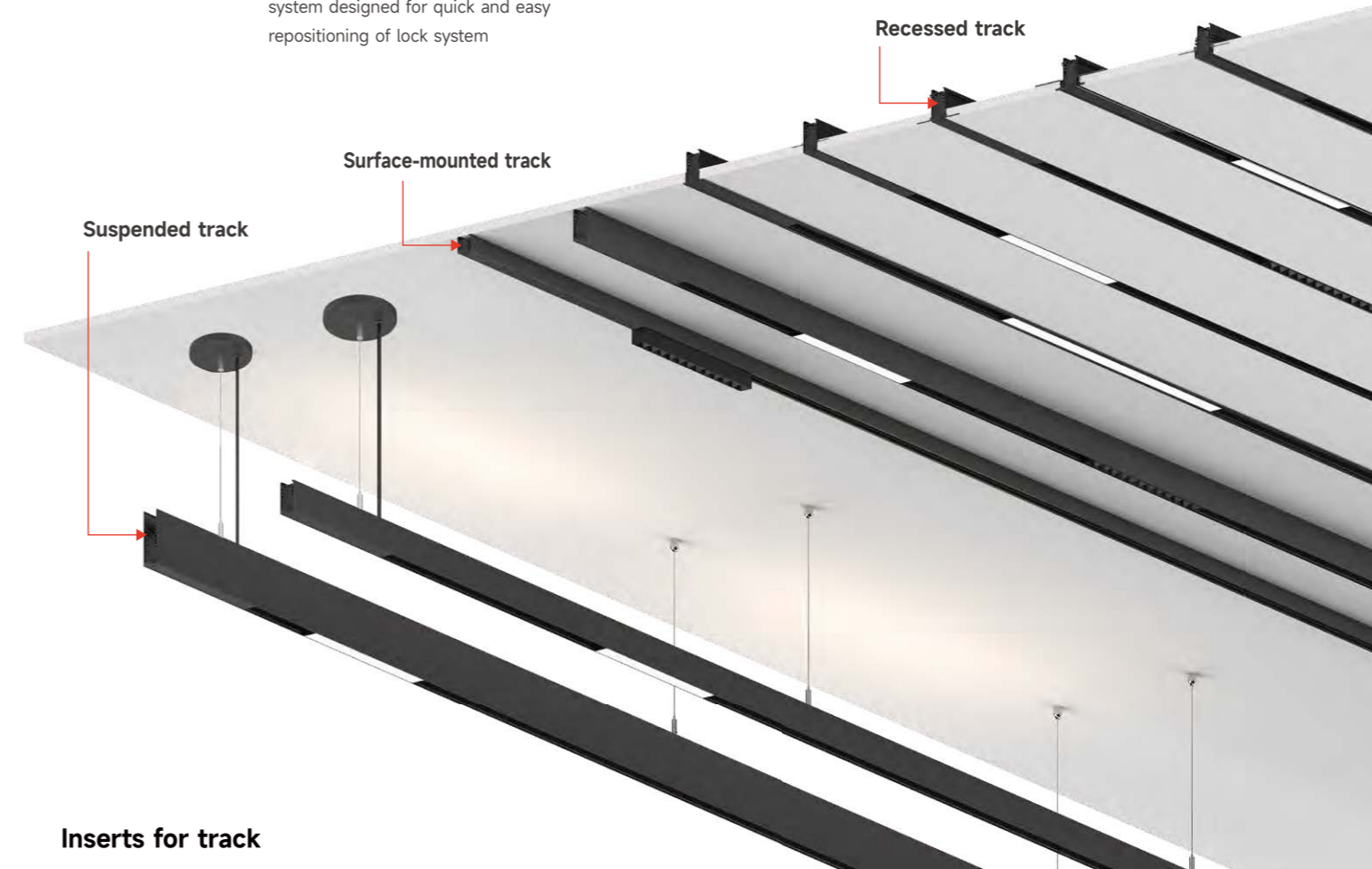

Inserts for track

Spotlight insert



Accent light insert



General light insert



Downlight insert



Comfort light insert



Decorative light insert

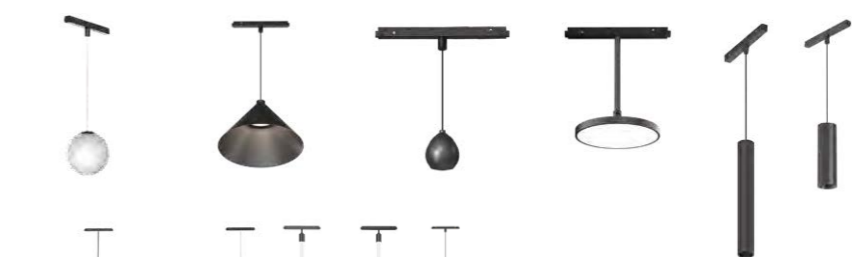

Wall washer insert



LINK30

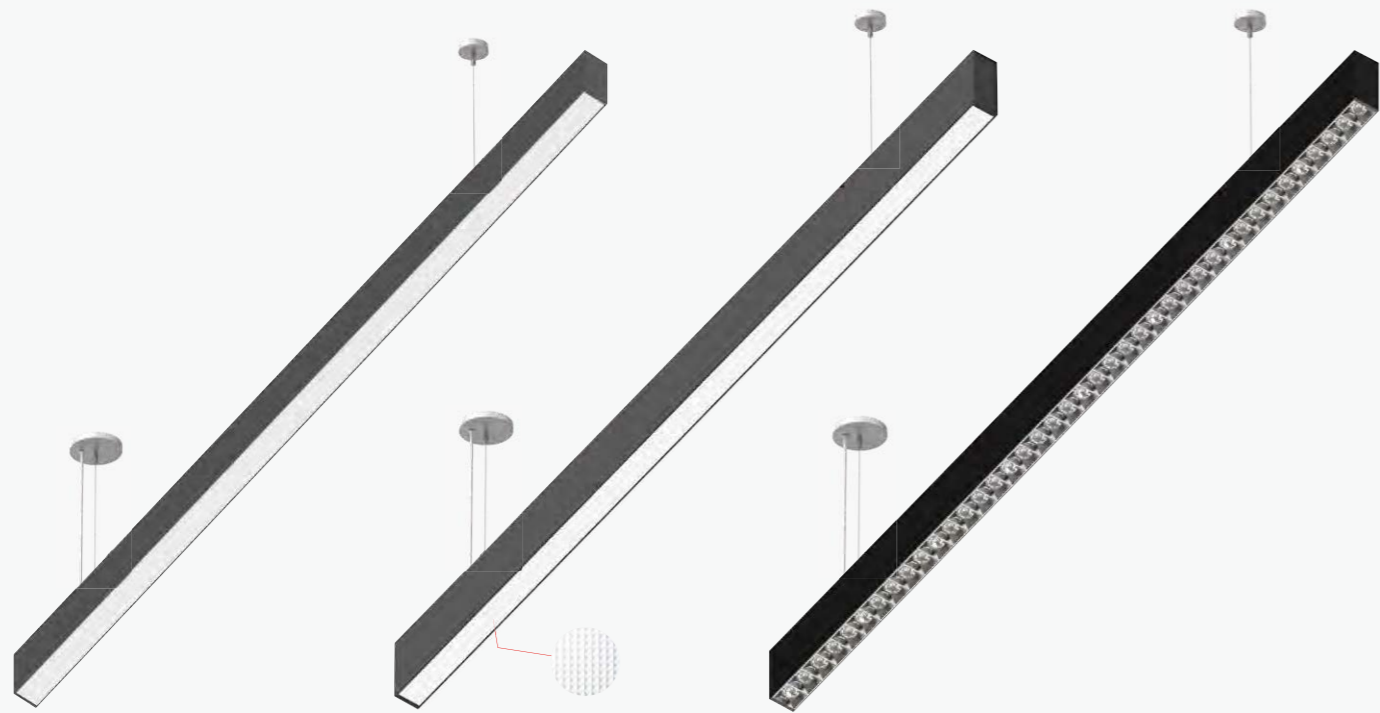

General Light

Comfort Light

Accent Light

Features

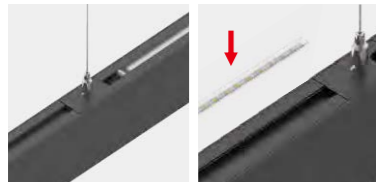

Switch for Uplight Up Light

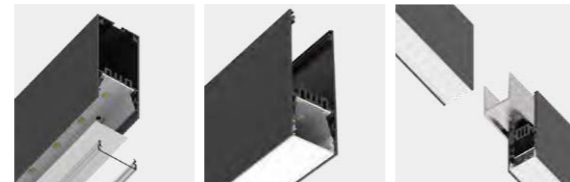

Opal Cover

Easy connection

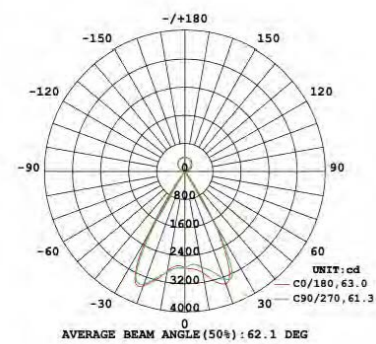

LINK60

Linear Lighting System

- UGR<19
- High efficacy
- Quick installation
- Suspended / Surface / Recessed Mounting
- White / Black color

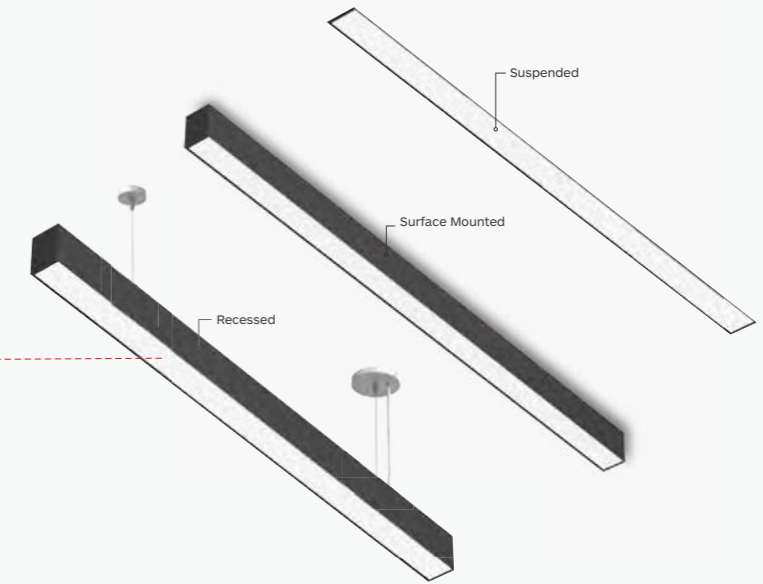

LINK 60-DL

- 25W 2600lm
- 33W 3300lm
- 38W 3800lm

LINK 60-UL (High Efficiency)

- 21W+17W 4900lm
- 26W+21W 6100lm

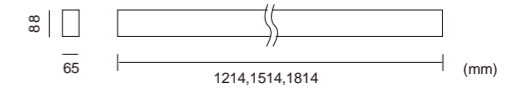

Ultra-long flexible diffuser

Up to 30m long without light leakage. Microprism craftsmanship, uniform and soft light.

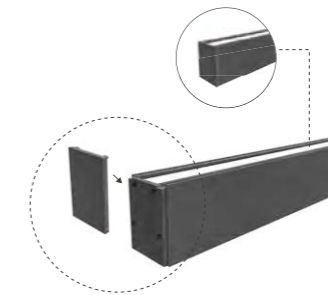

No light leakage

Double end cap design without light leakage and visible screws. Easy disassembly for continuous connection.



Surface mounted accessories

Rotary clip design for convenient installation.



Connection accessories

Four kinds of corner, No need complex cutting.

QUICK 50

- Continuous light lines composed of different module inserts, meeting the highest requirements in terms of architecture and lighting technology
- 1200mm / 1800mm



Suspended

Surface Mounted

Recessed



• AL Fixture

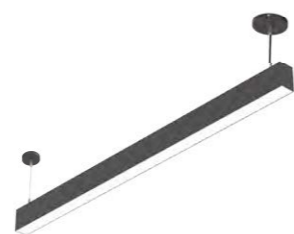

• GL Fixture

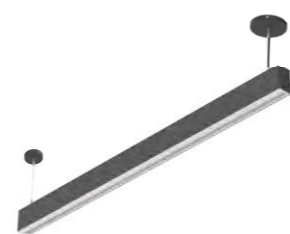

• WW Fixture



• SL Fixture



• AL+GL Fixture

START



Housing

Universal Input 120-277V standard
New Construction,
Frame-In Kit and Remodel available
TRIAC and 0/1-10V (dimming standard)
Driver easily accessible for replacement
Round and Square option

Trim

Round, square, Flanged, Flangeless available
Cut-out: $\Phi 3"$, $\Phi 4"$, $\Phi 5"$, $\Phi 6"$

Light source

Powder coated die-cast aluminum heat sink
CCT: 2700K, 3000K, 4000K
50,000 hours rated life

Optics

Lens and reflector available
Beam: 10°, 18°, 24°, 35°, 50°

Secondary reflector

Adjustable, fixed, wall washed available



TO MEET EVERY CODE AND ENVIRONMENT

NEW CONSTRUCTION HOUSING & REMODEL VERSION



New construction with housing suitable for insulated ceiling (IC)

Housing with hanger bars system for new construction installations. Suitable for insulated ceiling or applications. Housing and trim can be shipped separately.

Ceiling thickness: 1/2"



NEW CONSTRUCTION WITH PLASTER FRAME (NC)

Plaster frame with hanger bars system to be installed during rough-in phase. Suitable for non-insulated new construction ceiling assemblies, like sheetrock, acoustic tiles, or paneling. Housing and trim can be shipped separately.

Ceiling thickness: 1/2"



REMODEL(RM)

For new or existing ceiling. Suitable for non-insulated ceiling like sheetrock or paneling. Trimless frame kit can be shipped separately.

Ceiling thickness: 1/8" to 1" (1mm - 25mm)

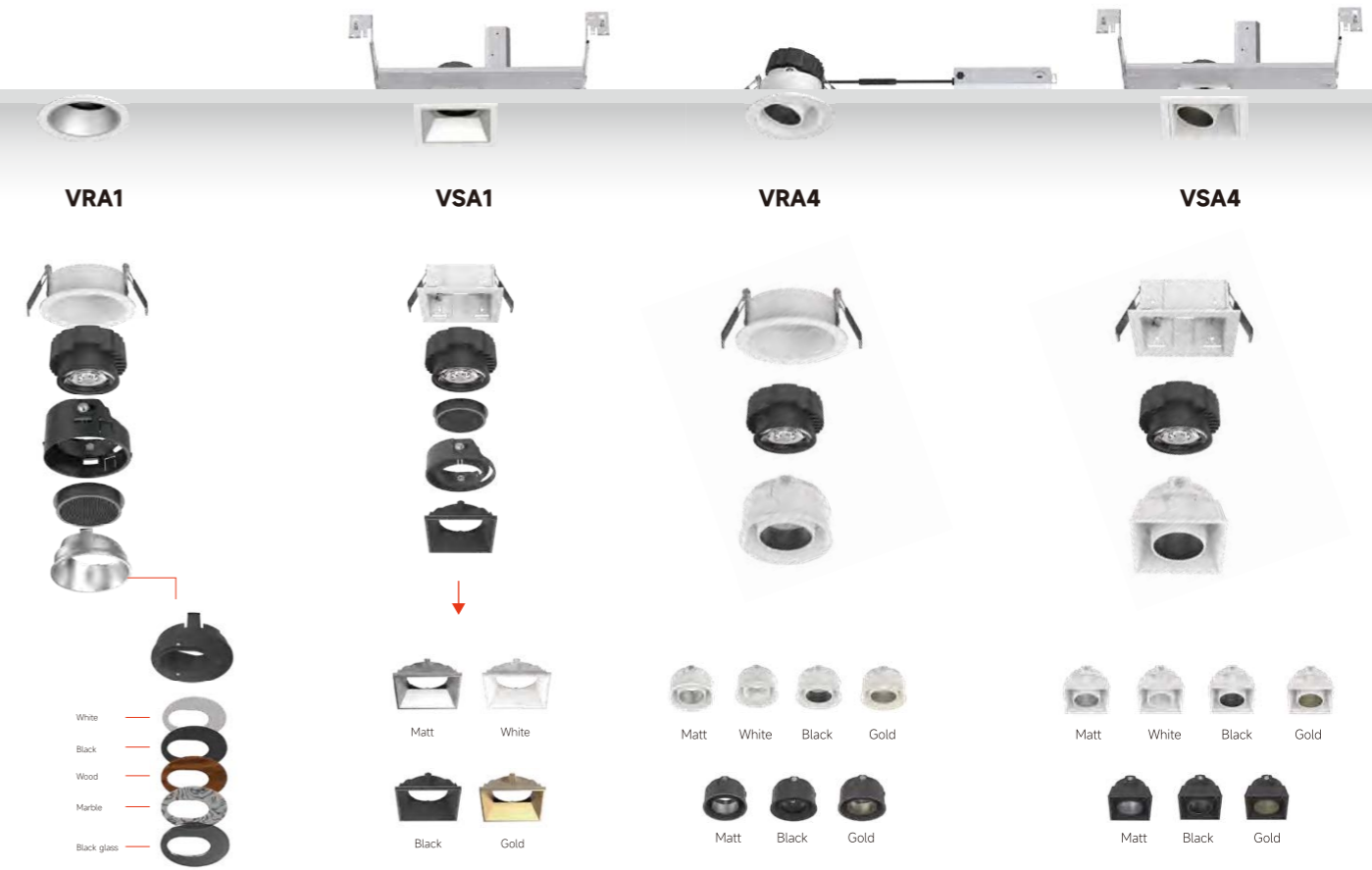

VTRIM

Perfect choice for specified architectural projects
 Compatible with LED Modules
 Wide range of design variants for different applications
 Available in trimless version
 Decorative rings painted in a variety of colors (black, white, marble, wood, etc.)
 Magnetic design for changing decorative ring without any tools



Fixed

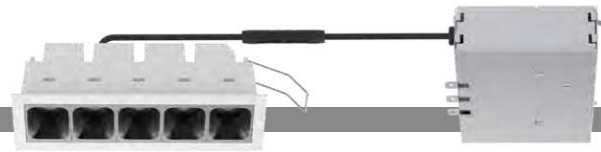

Adjustable



Wall Washer



Trimless



LF1
1 1/2" x 1 1/2"
2W 180Lm



LF2
2 1/2" x 1 1/2"
4W 350Lm



LF3
3 5/8" x 1 1/2"
7W 550Lm



LX4
2 5/8" x 2 5/8"
9W 700Lm



LF5
5 1/16" x 1 1/2"
13W 850Lm



LF10
11 1/8" x 1 1/2"
22W 1700Lm



LF3-LS1
5 1/16" x 1 1/2"
9W 650Lm

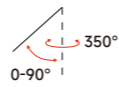

LF6-LS2
11 1/8" x 1 1/2"
17W 1300Lm



LA5
6 5/16" x 2 1/16"
11W 850Lm



LA10
11 3/4" x 2 1/16"
22W 1700Lm



LFT5
6 1/16" x 1 7/8"
13W 850Lm



LFT10
11 1/2" x 1 7/8"
22W 1700Lm



LFT3-LS1
6 1/16" x 1 7/8"
9W 650Lm



LFT6-LS2
11 1/2" x 1 7/8"
17W 1300Lm



LWT5
6 1/16" x 1 7/8"
11W 550Lm



LWT10
11 1/2" x 1 7/8"
22W 1100Lm



LW5
5 1/16" x 1 1/2"
11W 550Lm



LW10
11 1/8" x 1 1/2"
22W 1100Lm



LWT5
6 1/16" x 1 7/8"
11W 550Lm



LWT10
11 1/2" x 1 7/8"
22W 1100Lm



LEDGO

Fixed

A combination of deep recessed secondary reflector and soft lens creates visual comfort

Adjustable

Four sizes with LED wattages 9W-22W. 20°, 40°, and 50° beam angles are available. 10° beam angle is optional for SRA68. 30° tilt and 355° rotation.

Wall Washer

Asymmetric wall washer reflector evenly illuminates walls

Secondary Reflector



black white matt gold

Colour



white black

For complete product portfolio,
please refers to our electronic catalogue.

E-LITE[®]